

LED Profile

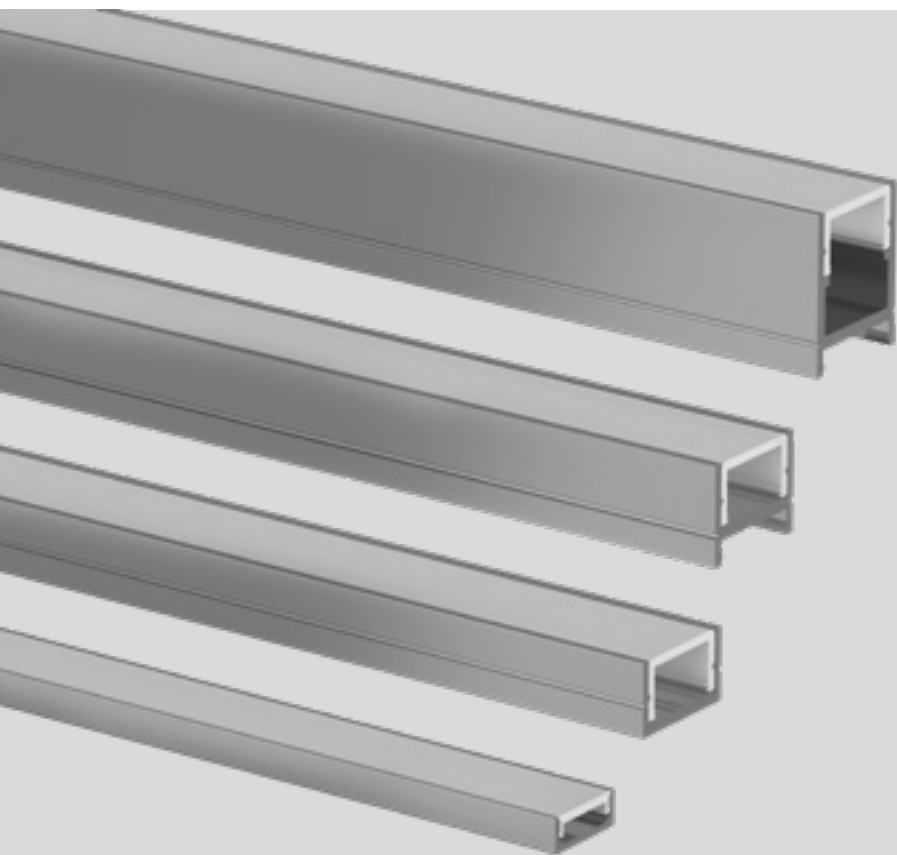

lightconsulting

LED PROFILE IM ÜBERBLICK

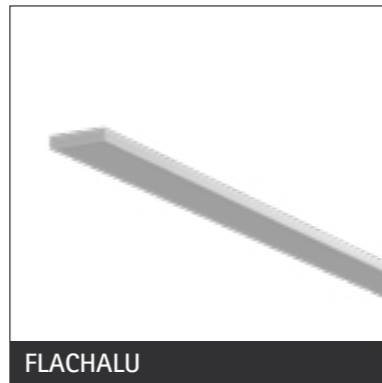

LED Profile

PROFIL LC CLIP HIGH

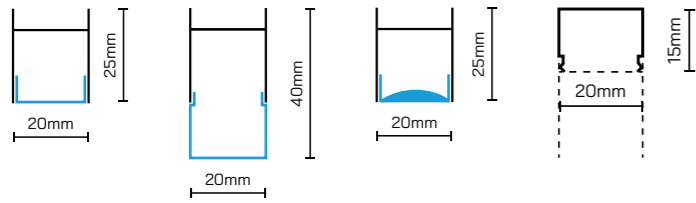

- Passend für LED-Bänder bis 20W/m in IP20 | IP68 und einer max. Breite von 16mm
- Ausführung mit Vergusstechnik IP67 | IP68 möglich
- Stangenlänge: 6100mm

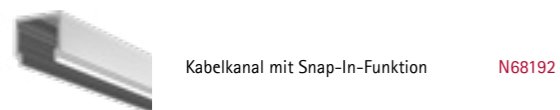
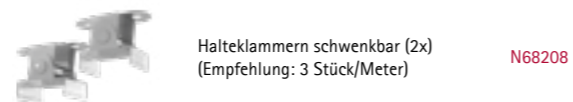
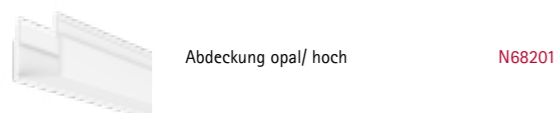
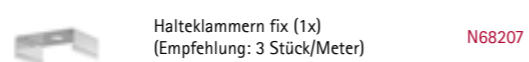
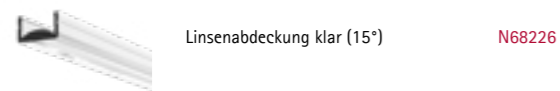
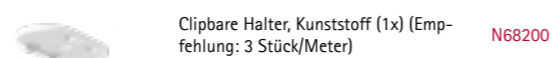
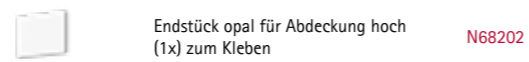
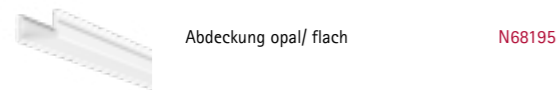
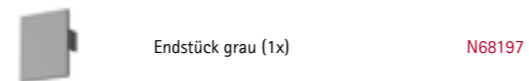
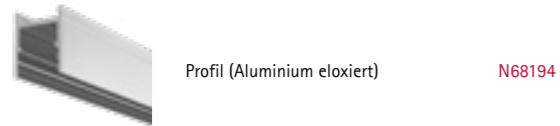
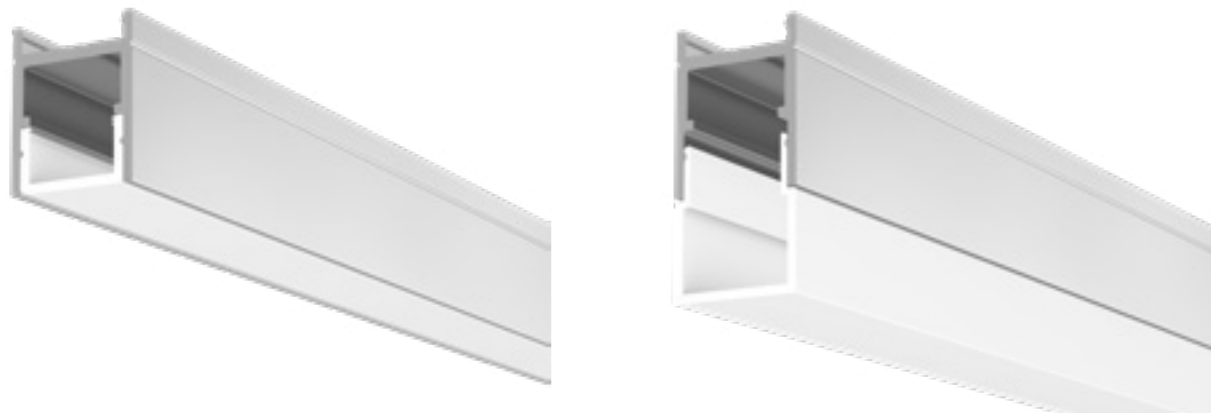

PROFIL LC CLIP LOW

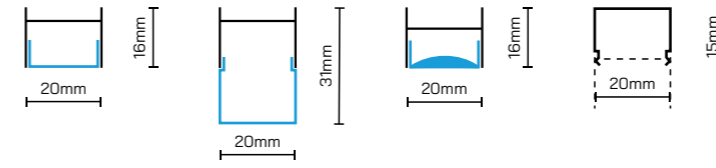

- Passend für LED-Bänder bis 20W/m in IP20 und einer max. Breite von 12mm
- Ausführung mit Vergusstechnik IP67 | IP68 möglich
- Stangenlänge: 6100mm

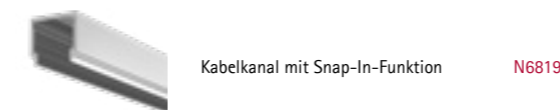
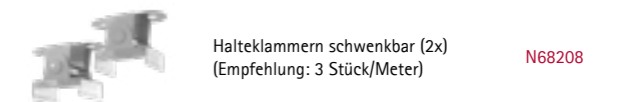
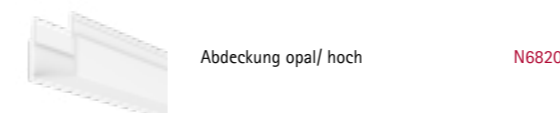
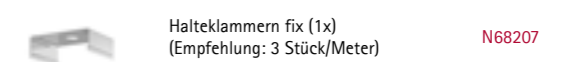
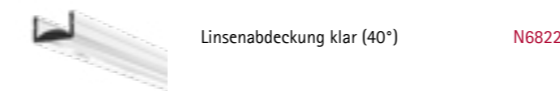
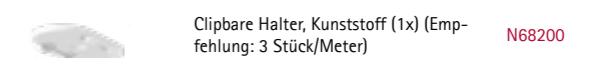
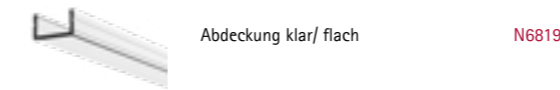
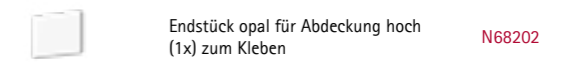
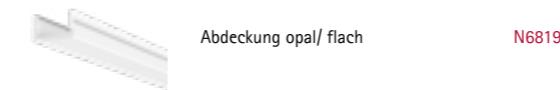
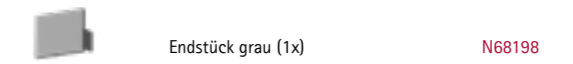
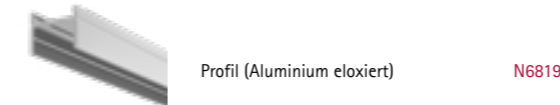
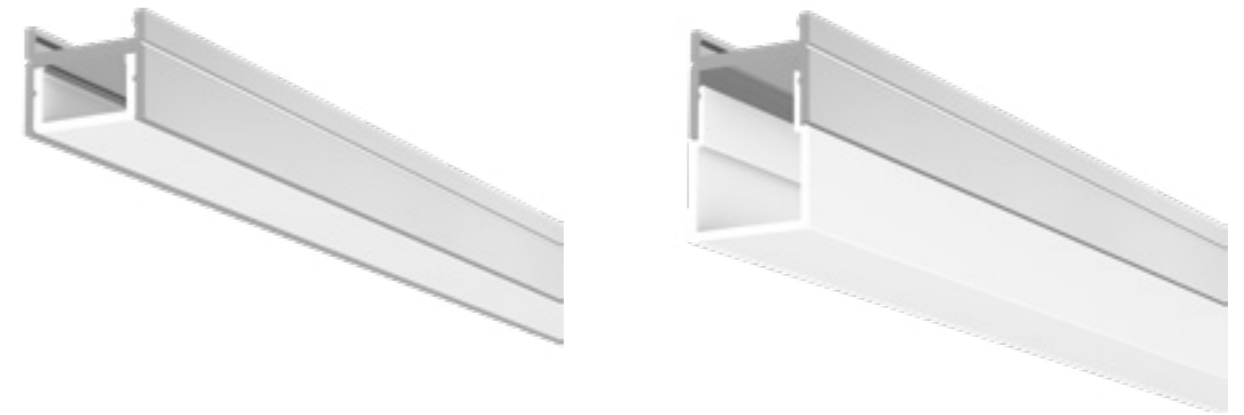

PROFIL LC MICRO 1

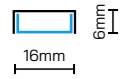

- Passend für LED-Bänder bis 10W/m in IP20 und einer max. Breite von 10mm
- Stangenlänge: 4100mm



Profil (Aluminium eloxiert)

N68203



Abdeckung klar/flach

N68206



Abdeckung opal/ flach

N68205



Endstück (1x)

N68217

PROFIL LC MICRO 2

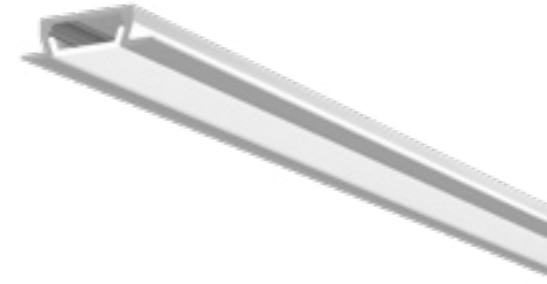
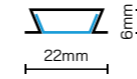

- Passend für LED-Bänder bis 10W/m in IP20 und einer max. Breite von 10mm
- Stangenlänge: 4100mm



Profil (Aluminium eloxiert)

PLB3775/1



Endstück grau mit
Kabelausgang (1x)

PL1448



Abdeckung opal/ flach

PL1547/1



Endstück grau (1x)

PL1430

PROFIL FLACHALU

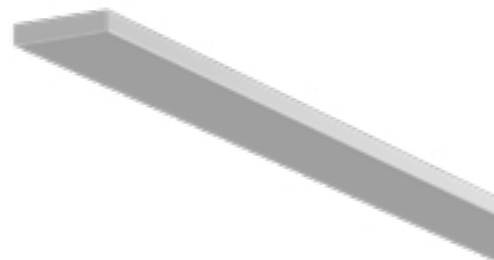

- Passend für LED-Bänder bis 10W/m in IP20 und einer max. Breite von 10mm
- Stangenlänge: 2000mm

Flachalu

N68240



PROFIL LC MICRO-3A

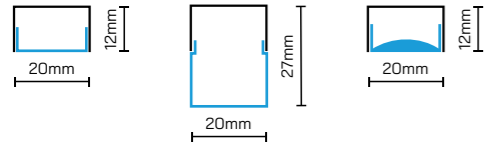

- Passend für LED-Bänder bis 20W/m in IP20 und einer max. Breite von 12mm
- Ausführung mit Vergusstechnik IP67 | IP68 möglich
- Stangenlänge: 6100mm

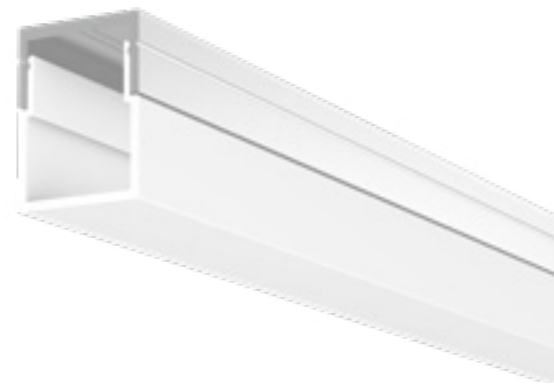

Profil (Aluminium eloxiert)

N68191



Endstück grau (1x)

N68199



Abdeckung opal/ flach

N68195



Endstück opal für Abdeckung hoch (1x) zum Kleben

N68202



Abdeckung klar/flach

N68196



Halteklammern fix (1x)
(Empfehlung: 3 Stück/Meter)

N68207



Linsenabdeckung klar (40°)

N68226



Halteklammern schwenkbar (2x)
(Empfehlung: 3 Stück/Meter)

N68208



Abdeckung opal/ hoch

N68201

PROFIL LC MICRO-3EB

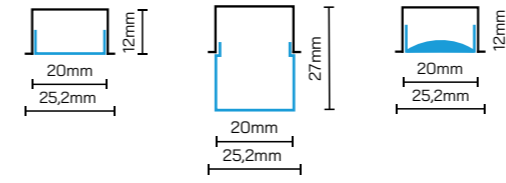

- Passend für LED-Bänder bis 20W/m in IP20 und einer max. Breite von 12mm
- Ausführung mit Vergusstechnik IP67 | IP68 möglich
- Stangenlänge: 6100mm

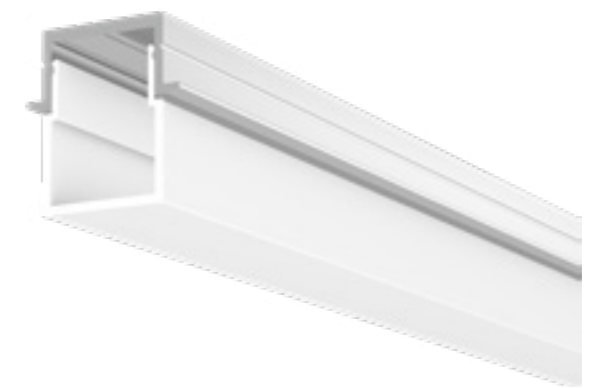
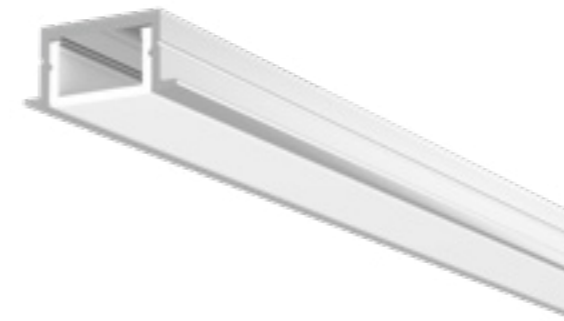

Profil (Aluminium eloxiert)

N68190



Abdeckung opal/ hoch

N68201



Abdeckung opal/ flach

N68195



Endstück grau (1x)

N68218



Abdeckung klar/ flach

N68196



Endstück opal für Abdeckung hoch (1x) zum Kleben

N68202



Linsenabdeckung klar (40°)

N68226

PROFIL LC MICRO-5 SMALL

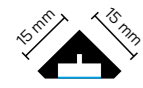

- Passend für LED-Bänder bis 10W/m in IP20 und einer max. Breite von 10mm
- Stangenlänge: 4100mm



Profil (Aluminium eloxiert)

N68204



Abdeckung klar/flach

N68206



Abdeckung opal/ flach

N68205



Endstück (1x)

N68219

PROFIL LC MICRO-5 MEDIUM

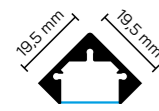

- Passend für LED-Bänder bis 15W/m in IP20 und einer max. Breite von 10mm
- Stangenlänge: 2000mm



Profil, Aluminium eloxiert

MEMCLE0140AR200



Abdeckung klar/flach

MEMCLE0100TR



Profil, Aluminium schwarz

MEMCLE0140VB200



Abdeckung schwarz/flach

MEMCLE0100PMFRN2



Profil, Aluminium weiß

MEMCLE0140VN200



Endstück Set
(1x geschlossen,
1x mit Schlitz)

alu
schwarz
weiss
MEMCLE0140ZK5PG
MEMCLE0140ZK5PN
MEMCLE0140ZK5PB



Abdeckung opal/flach

MEMCLE0100OP



Edelstahlklammern Set

MEMCLEDA040

PROFIL LC MICRO-5 LARGE

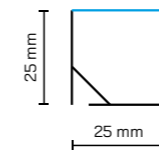
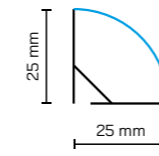

- Passend für LED-Bänder bis 20W/m in IP68 und einer max. Breite von 15mm
- Stangenlänge: 2000mm

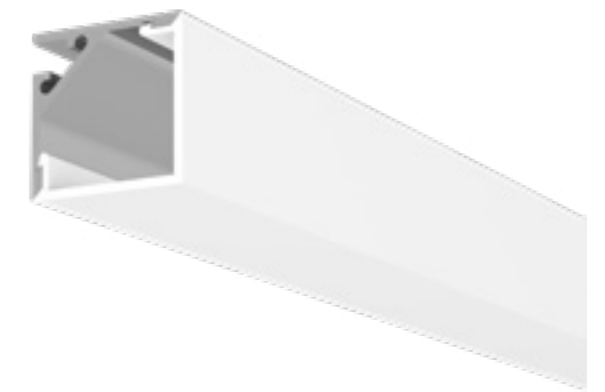
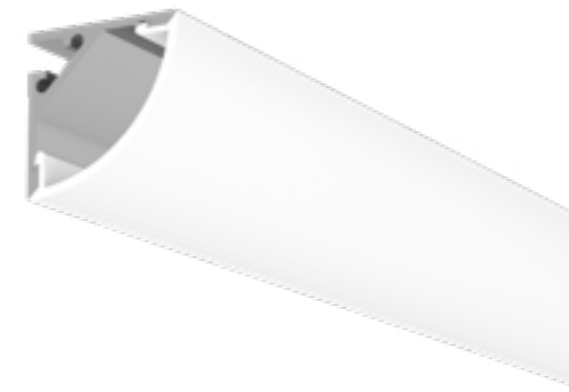

Profil MICRO-5 LARGE
(Aluminium)

AUT-AP-004-001



Endkappe rund mit Langloch (1x)

AUT-EK-004-1112



Abdeckung opal/ rund

AUT-AB-004-006



Endkappe eckig geschlossen (1x)

AUT-EK-004-100



Abdeckung opal/ eckig

AUT-AB-004-003



Endkappe eckig mit Langloch (1x)

AUT-EK-004-101



Endkappe rund geschlossen (1x)

AUT-EK-004-110



PROFIL LC MICRO-13

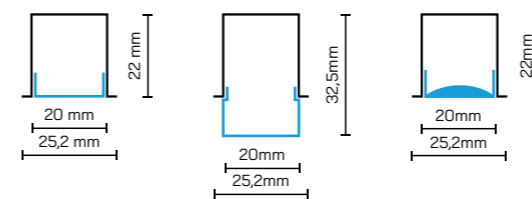

- Passend für LED-Bänder bis 20W/m in IP20 | IP68 und einer max. Breite von 16mm
- Ausführung mit Vergusstechnik IP67 | IP68 möglich
- Stangenlänge: 6100mm

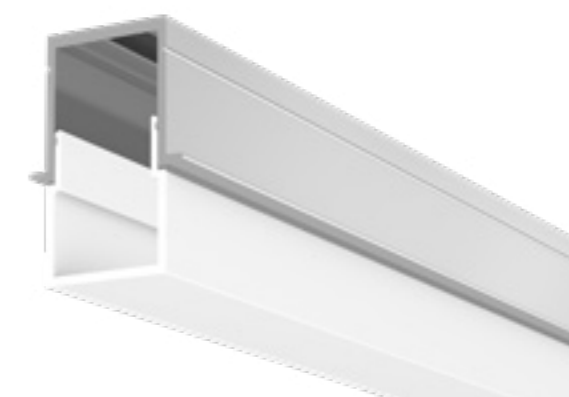

Profil (Aluminium eloxiert)

N68215



Abdeckung opal/ hoch

N68201



Abdeckung opal/flach

N68195



Endstück grau (1x)

N68220



Abdeckung klar/flach

N68196



Endstück opal für Abdeckung hoch (1x) zum Kleben

N68202



Linsenabdeckung klar (15°)

N68226



Einbaubügel (1x)
(Empfehlung: 3 Stück/Meter)

N68225

lightconsulting

Lightconsulting GmbH
Chieminger Straße 12A
83355 Grabenstätt

Phone +49 8661 983 44 77
info@lightconsulting.de
www.lightconsulting.de

Editor, Design, Idea, Lightconsulting GmbH

Photographs: Ulrich Steinlechner, bild[ART]isten, Austria | Daniel Thalmann, Switzerland | Hannes Dabernig, Austria | Steve troes fotodesign | Horn Fotografie | Stefan Müller Fotografie
Produkte mit DUOBUS Komponenten wurden in Kooperation mit SO-U-L Holger Solbach entwickelt.

Allgemeine Verkaufs- und Lieferbedingungen finden Sie auf unserer Website. Alle Maßeinheiten wurden in Millimeter angegeben. Kopien und Auszüge aus dem Katalog oder Teile davon zu entnehmen, ist nur durch vorhergehende schriftliche Anfrage bzw. nachfolgendem und nachweisbarem Einverständnis des Herausgebers erlaubt. Der Herausgeber haftet nicht für eventuelle Druck- oder Satzfehler. Die in diesem Katalog angeführten Skizzen-, Größen-, Material- und Farbangaben sind rein indikativer Natur. Die Firma behält sich das Recht vor Charakteristika der Produkte jederzeit, ohne vorheriger Ankündigung zu ändern. Druckfehler und Irrtümer vorbehalten. Für alle Produkte gelten unsere AGB, sowie Liefer- und Zahlungsbedingungen.